



Warm Up

Grade 8

April 20, 2016



Draw the views of the front, left, right and top.

-include mat plan

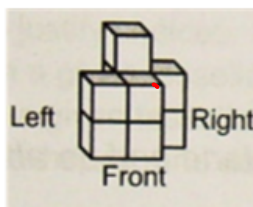

Front Left Right

Top

Review for assessment

Model 4×2 using the box method

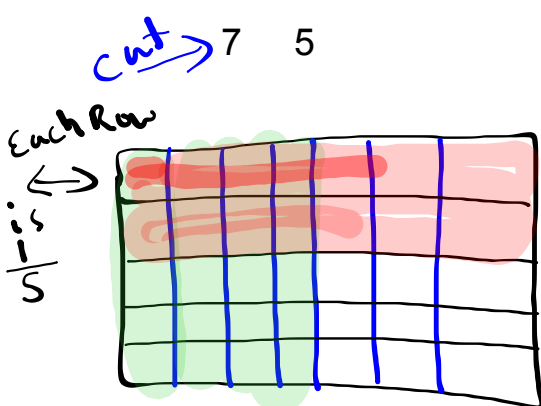

Shade 4 Column ($\frac{4}{7}$)

Shade in 2 rows out of 5

$\frac{2}{5}$

Overlap total Block is answer

$$\frac{8}{35}$$

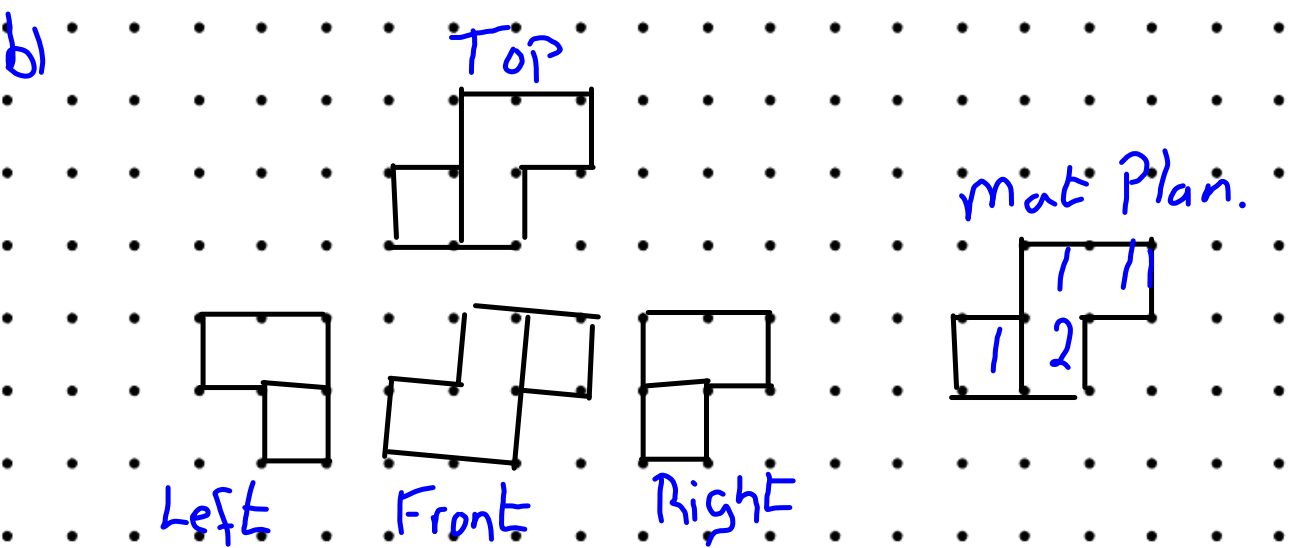
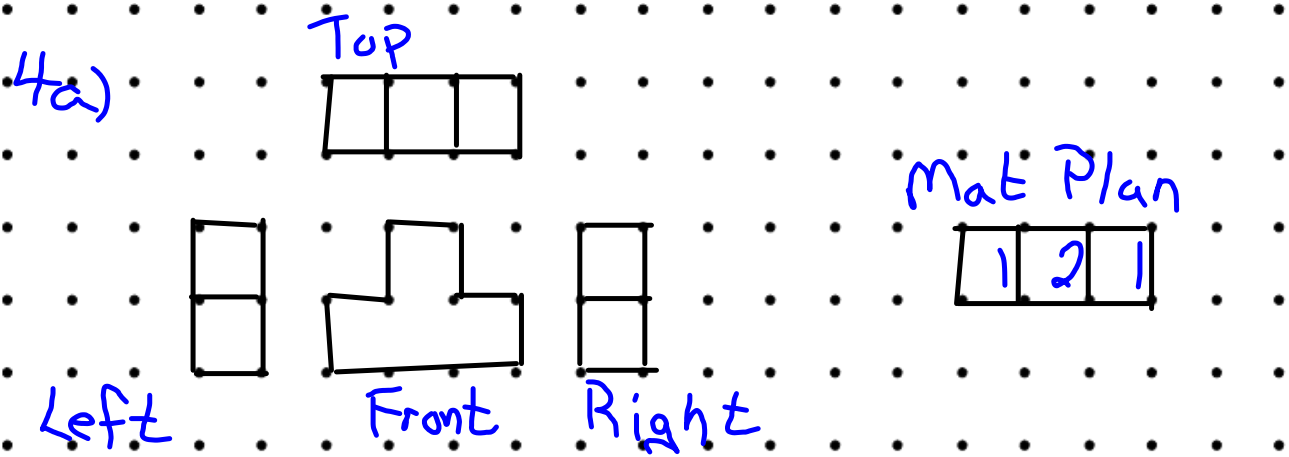

Sample Solutions

4. a)

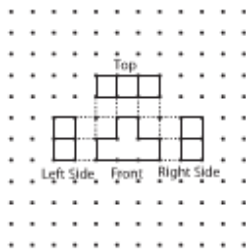

b)

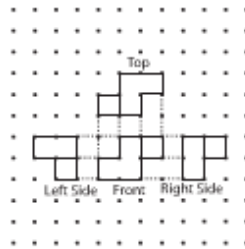

c)

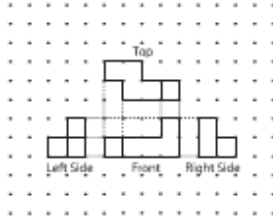

Sample Solutions

5.

	Top	Front	Back	Left Side	Right Side
A	P	N	N	N	N
B	N	N	N	Q	L
C	Q	Q	L	Q	L
D	J	Q	L	L	Q
E	K	Q	L	M	M

6.

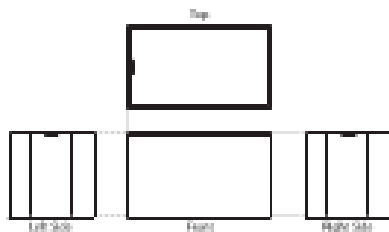

7. a)

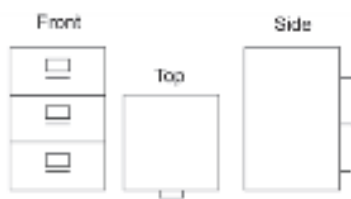

b)



c)

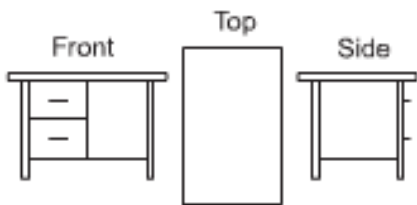

8.

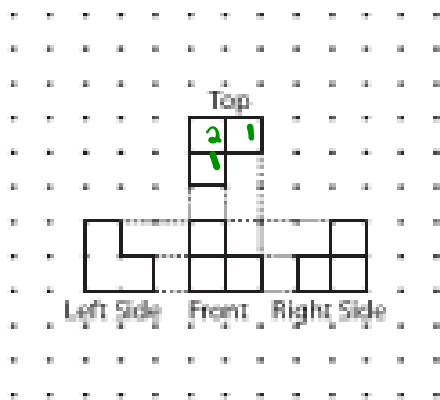

9.

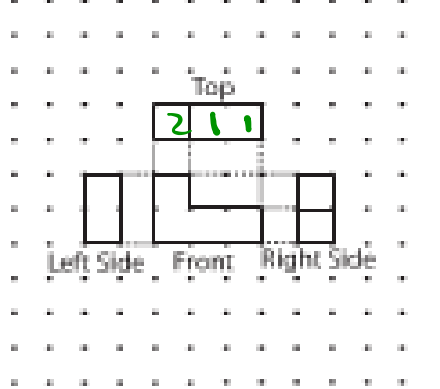

10.

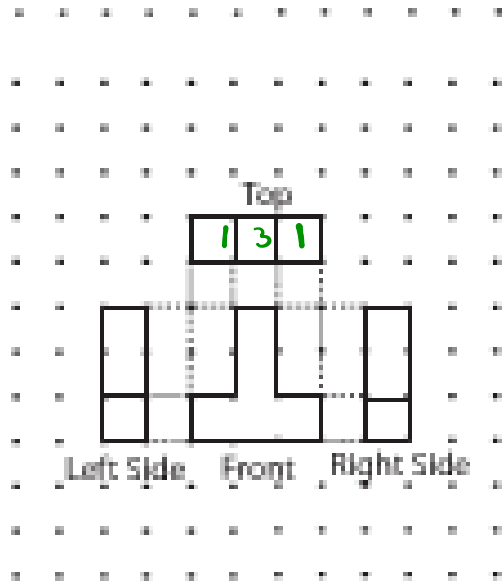

12.

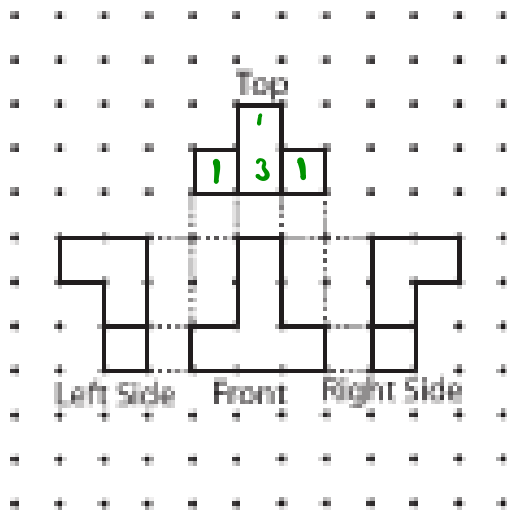

13.

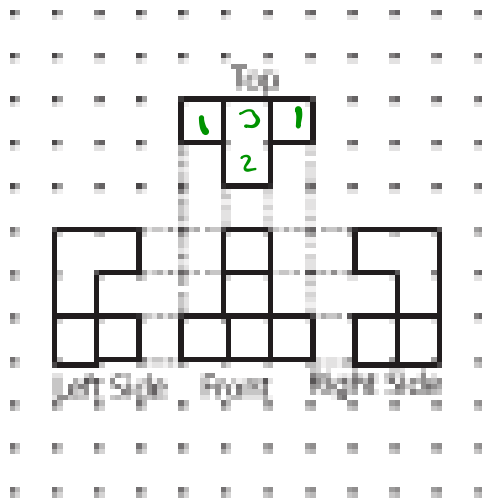

14.

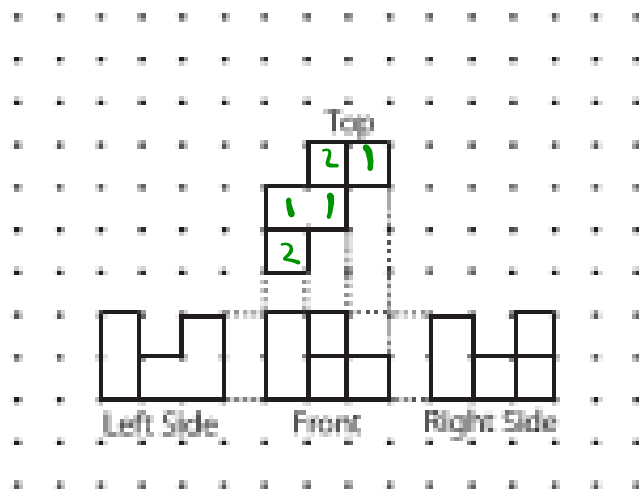

15. There are 7 possible objects.

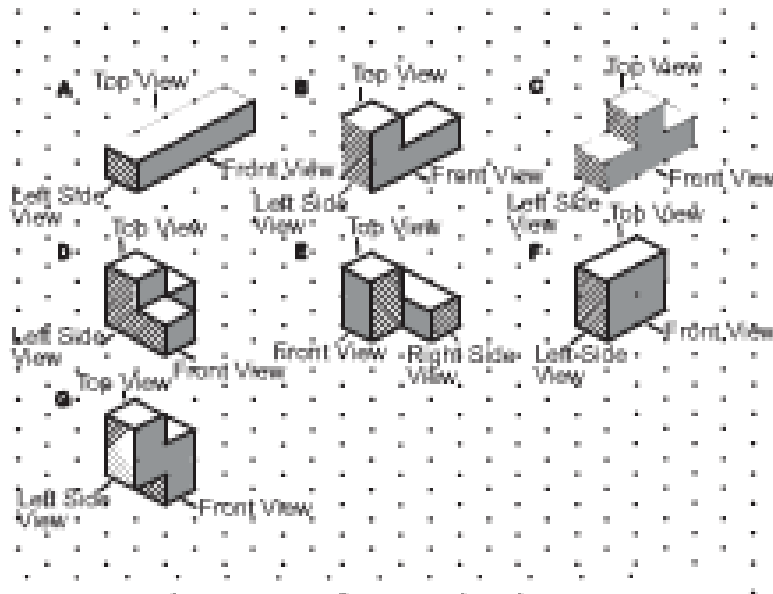

Here are the views for each object.

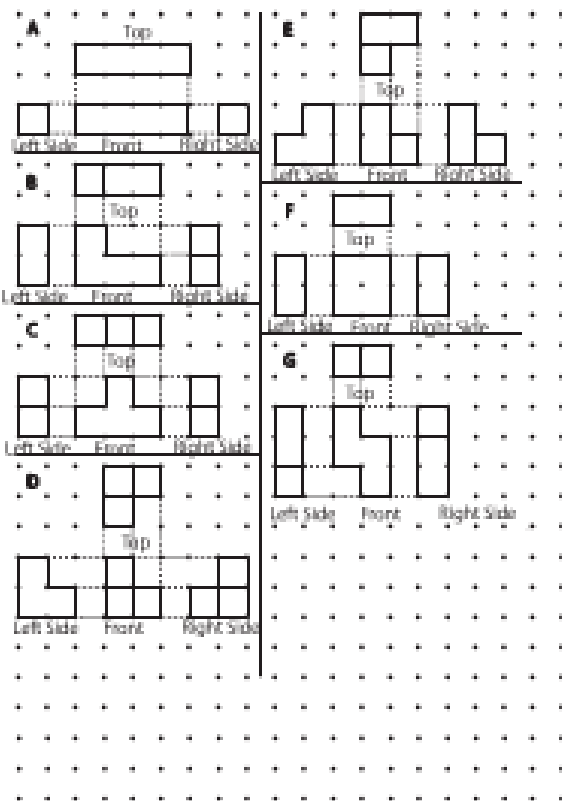

16.

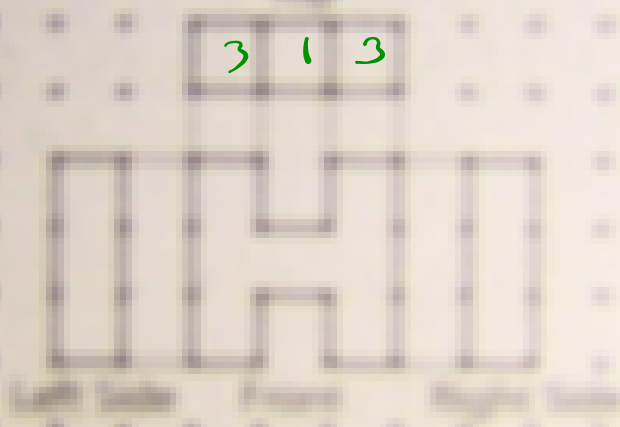



An axis can be rotated horizontally

-when an object is rotated horizontally the axis of rotations is vertical. (Can rotate clockwise or counterclockwise)

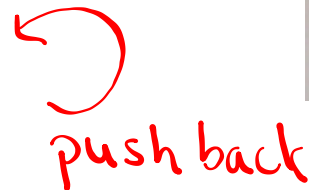
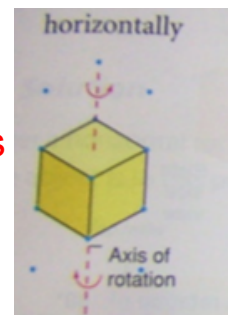

An axis can be rotated vertically

-when an object is rotated vertically the axis of rotations is horizontal. (Can rotate towards or away from you)

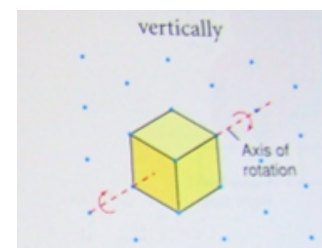

Always build then rotate

Draw the views (But let's put them in relation to each with the front in the center)

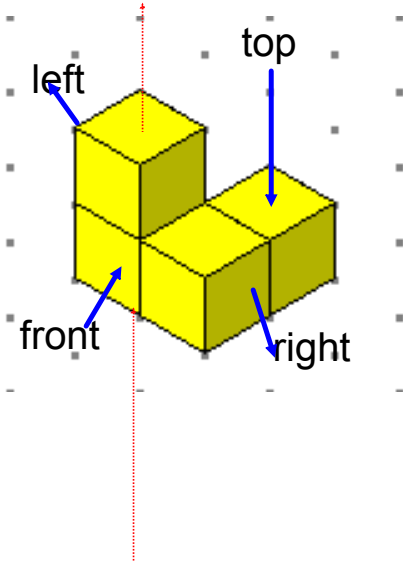

Square Dot Paper Grid Master

Front Left Right Top

Same as last page but let's rotate horizontally 180° . Now draw the views over (New front, new top, new left, new right)

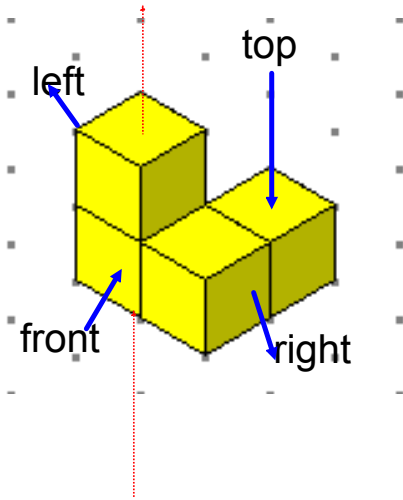

Square Dot Paper Grid Master

New front



NewLeft



NewRight

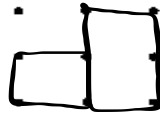

Newtop



Draw the views after we rotate vertically about the axis 180° .

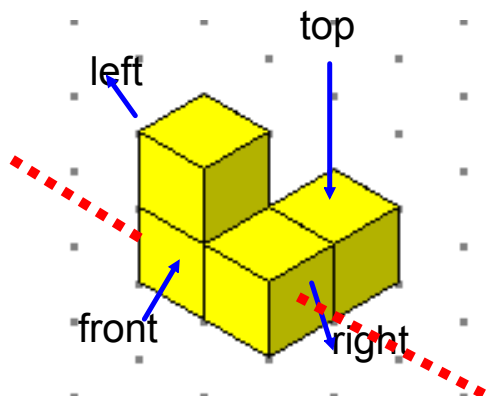

Square Dot Paper Grid Master

New front



New left



New Right



New top

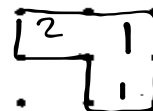

Draw the views after we rotate horizontally 270° . (Which is the same as 90 degrees counterclockwise)

↓ 3 turns clockwise

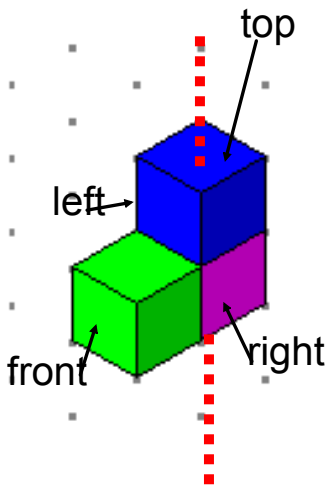

Square Dot Paper Grid Master

Original

Front	Left	Right	Top
New Front	New Left	New Right	New Top

Class/Homework

Page 444 - 446

#3, #4, ~~#5~~, 6, #7, #8, #9

b (ii)
(ab)
b (iii)

